

Data Sheet



Article number: 5863503111

Description: Ball Valve 350.311/1, G 3/4" - G 3/4"
Thread/Thread

Measures

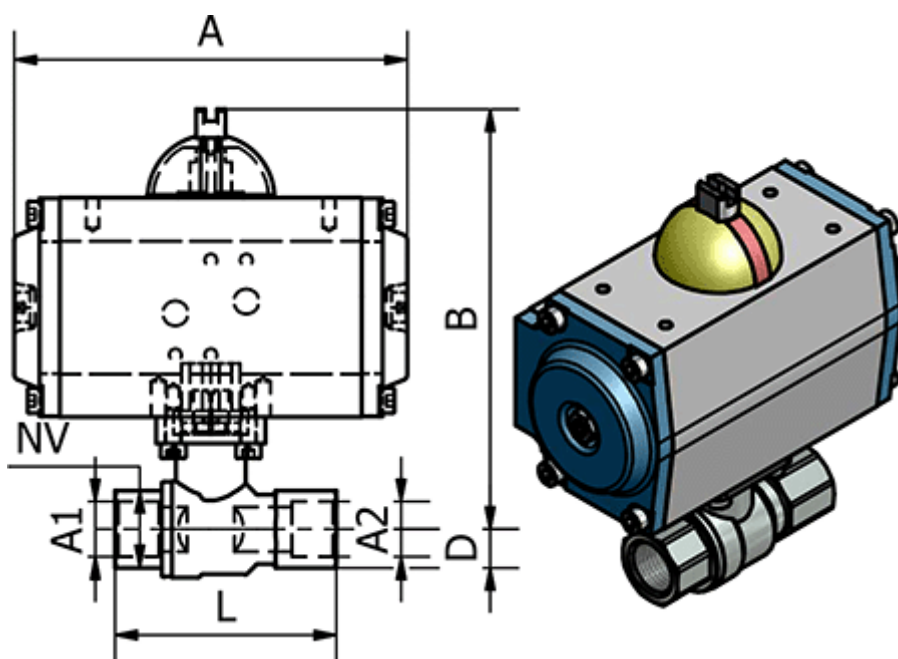

A	= 116
B	= 136
Connecting A1	= G 3/4"
Connecting A2	= G 3/4"
D	= 20
L	= 80
Max. Operating Pressure	= 40 bar
NV	= 32